

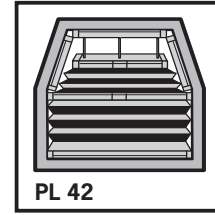

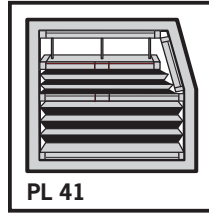

**Wichtig! Bitte mit der Pflegeanleitung aufbewahren!**  
**Important! Please keep together with care instructions!**  
**Let op! Bewaren samen met de houidinstructies!**  
**Important! Conserver ensemble avec les conseils d'entretien!**  
**Importante! Conservare con le istruzioni per la manutenzione!**  
**Важное указание! ПроСьба хранить вместе с руководством по уходу!**

# PL41, PL42



## Montage · Fitting · Montage · Montaggio · Монтаж

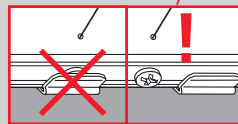
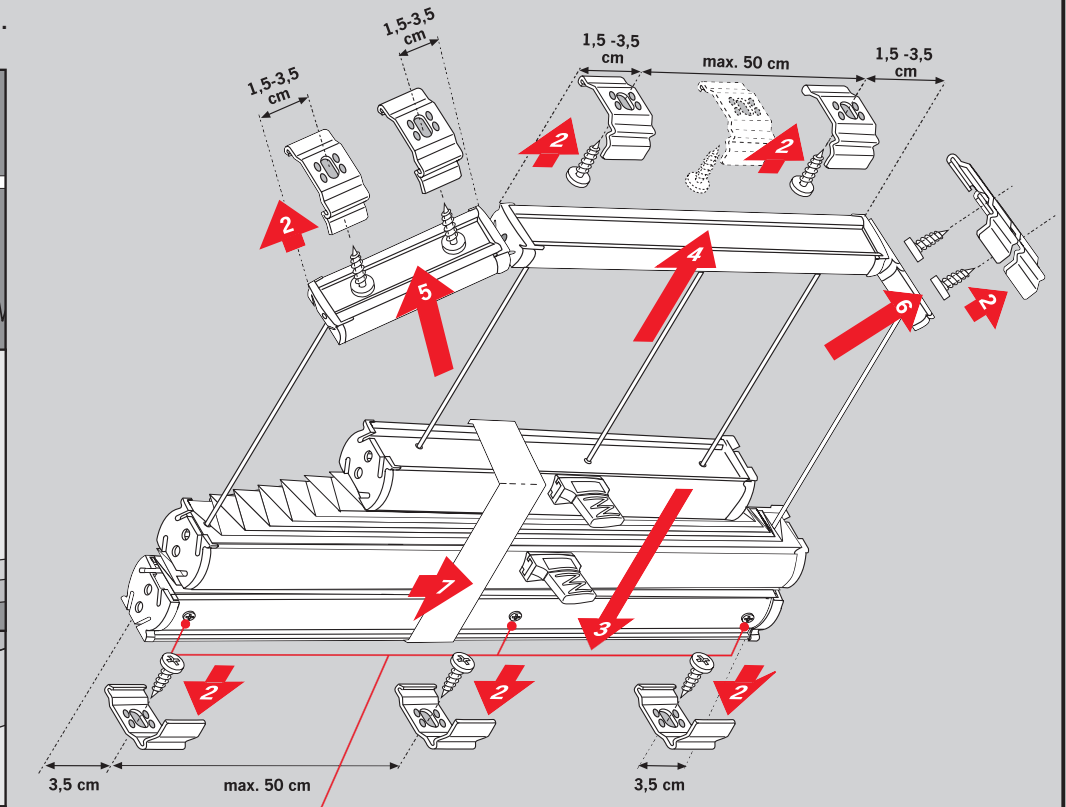
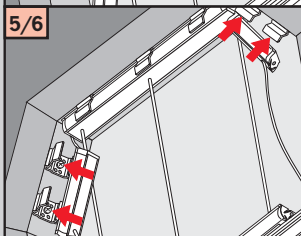
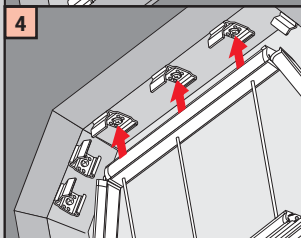
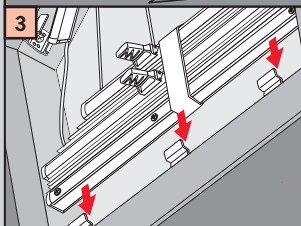
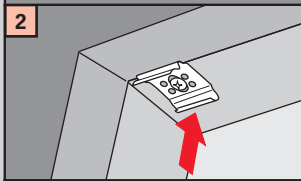
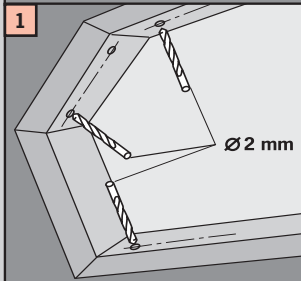
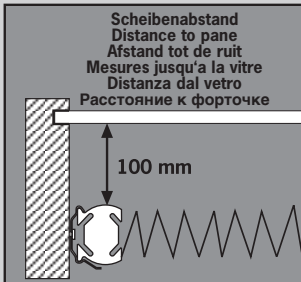

**Bedienung · Operation**  
 · Bedienung · Manœuvre  
 · Comando · Обслуживание

**Demontage · Dissassembly**  
 · Demontage · Démontage  
 · Smontaggio · Демонтаж

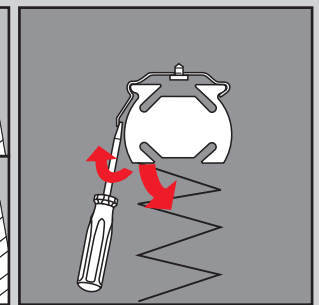
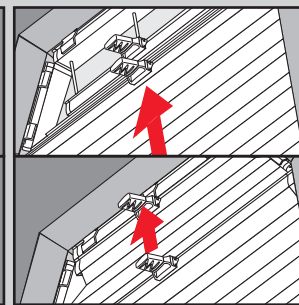
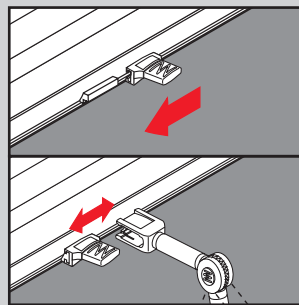

**Drähte spannen · tension the wires · draden spannen**  
 · tendre les fils · tirare il filo metallico · натягивать проволоку

