

Verrastung VS

Snap mechanism VS
Profiel Vergrendeling VS
Enclenchement VS
Bloccaggio VS
стопов VS

Wichtig! Bitte mit der Pflegeanleitung aufbewahren!
Important! Please keep together with care instructions!
Belangrijk! A.u.b. bij de gebruiksaanwijzing bewaren!
Important! Conserver ensemble avec les conseils d'entretien!
Importante! Conservare con le istruzioni per la manutenzione!
Важное указание!
Просьба хранить вместе с руководством по уходу!

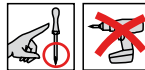

Demontage • Disassembly • Demontage • Démontage Smontaggio • Демонтаж

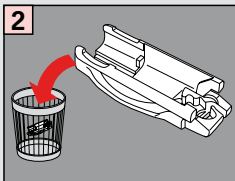
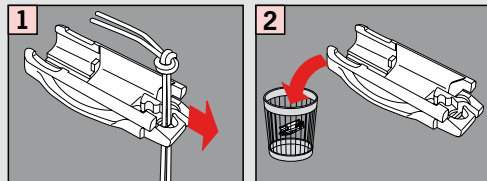

Montage • Fitting Montage • Montaggio Монтаж

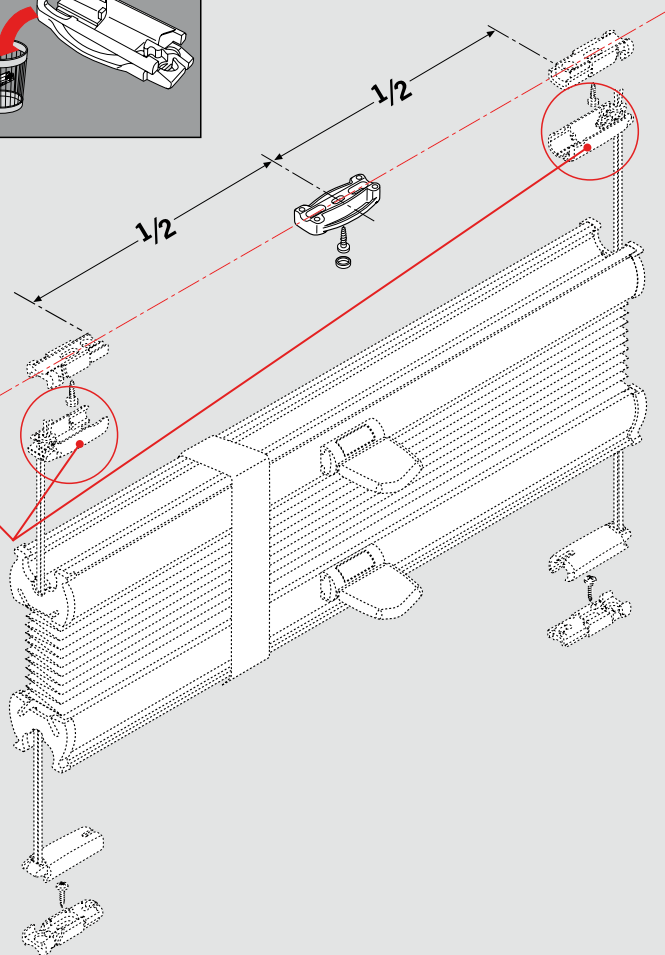
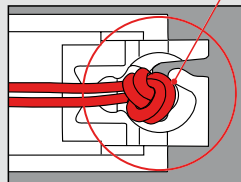
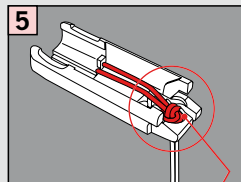
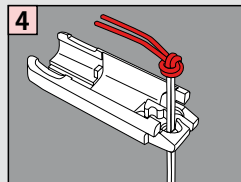
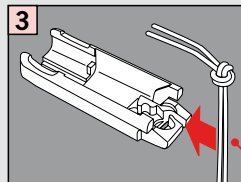

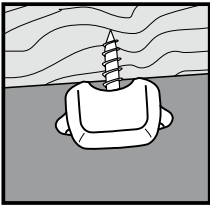

**Falzmontage,
Top fixing,
Bevestiging in de sponning,
Dans la feuillure,
Montaggio nella piegatura,
Образование складок**



**Montage • Fitting
Montage • Montaggio
Монтаж**

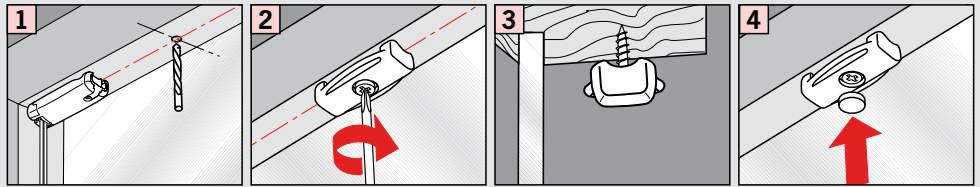
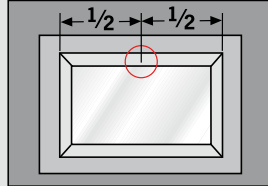

**Schließen • Close • sluiten • Fermeture
Chiusura • закрывать**

**Öffnen • Open • Openen • Ouverture
Apertura • открывать**

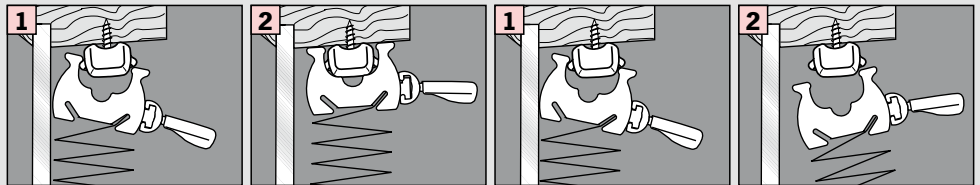

Demontage • Disassembly • Demontage • Démontage Smontaggio • Демонтаж

